



Volvo Construction Equipment

L150H, L180H, L220H

Volvo Wheel Loaders 24.4-34.5 t 299-373 hp



A passion for performance

At Volvo Construction Equipment, we're not just coming along for the ride. Developing products and services that raise productivity – we are confident we can lower costs and increase profits for industry experts. Part of the Volvo Group, we are passionate about innovative solutions to help you work smarter – not harder.

Helping you to do more.

Doing more with less is a trademark of Volvo Construction Equipment. High productivity has long been married to low energy consumption, ease of use and durability. When it comes to lowering life-cycle costs, Volvo is in a class of its own.

Designed to fit your needs.

There is a lot riding on creating solutions that are suited to the particular needs of different industry applications. Innovation often involves high technology – but it doesn't always have to. Some of our best ideas have been simple, based on a clear and deep understanding of our customers' working lives.



You learn a lot in 180 years.

Over the years, Volvo has advanced solutions that have revolutionized the use of construction equipment. No other name speaks Safety louder than Volvo. Protecting operators, those around them and minimizing our environmental impact are traditional values that continue to shape our product design philosophy.

We're on your side.

We back the Volvo brand with the best people. Volvo is truly a global enterprise, one that is on standby to support customers quickly and efficiently – wherever they are.

We have a passion for performance.



Volvo Trucks



Renault Trucks



Mack Trucks



UD Trucks



Volvo Buses



Volvo Construction Equipment



Volvo Penta



Volvo Financial Services



Innovative fuel efficiency.

Since Volvo Construction Equipment began designing wheel loaders in 1954, machine owners and operators have got to know the legendary reputation of these productive, fuel efficient machines. The new H-Series wheel loaders feature state-of-the-art technology such as OptiShift – a unique technical advancement which reduces fuel consumption by up to 18% and increases machine performance.

Reverse By Braking (RBB)

RBB is ideal for short cycle or truck loading applications. When the operator changes direction the Volvo patented RBB function senses the loader's direction and slows the machine by applying the service brakes automatically. This increases fuel efficiency, improves operator comfort and increases machine lifetime.

Intelligent hydraulics

Volvo's load-sensing hydraulics, combined with the fuel efficient Volvo engine, supply power to the hydraulic functions according to demand, to boost efficiency and lower fuel consumption. The system ensures fast response for shorter cycle times while delivering smooth operation through superior control of both the load and the attachment.



OptiShift
Volvo's OptiShift technology combines the company's patented Reverse By Braking (RBB) technology, with lock-up available from first to fourth gear, to boost productivity and efficiency in all applications. Lock-up creates a direct drive between the engine and transmission – eliminating power losses in the torque converter and reducing fuel consumption by up to 18%.

Eco pedal

Volvo's unique eco pedal applies mechanical push-back force when the accelerator is used excessively and engine rpm is about to exceed the economic operating range. This encourages the operator to ease off the throttle, reducing fuel consumption.

APS/FAPS

Automatic Power Shift (APS) and Fully Automatic Power Shift (FAPS) ensure optimal operation by adjusting the machine gears in line with parameters including engine and travel speed. This delivers fast cycle times and low fuel consumption. With APS the operator manually shifts down to first gear when more power is needed but with FAPS it's automatic.

Comfort boosts productivity.

At Volvo we know that when operators are comfortable they experience less fatigue and work more productively. That's why Volvo's industry-leading cab has been designed with the operator in focus – providing a spacious, safe and quiet environment that's perfect for optimizing productivity all day long.

Information panel

The display clearly presents the operator with vital machine information including fuel and oil levels and warning messages – ensuring optimal operation. From the operator seat, basic configurations and tests can be performed via the panel – which is easy-to-read even in bright sunlight.

Cab air filter

The cab air intake is located high on the machine, where air is cleanest. The easy-to-replace pre-filter separates coarser dust and particles before the air passes through the main filter and finally enters the cab. Volvo's industry-leading design allows 90% of the cab air to be recirculated through the main filter for continuous dust removal.

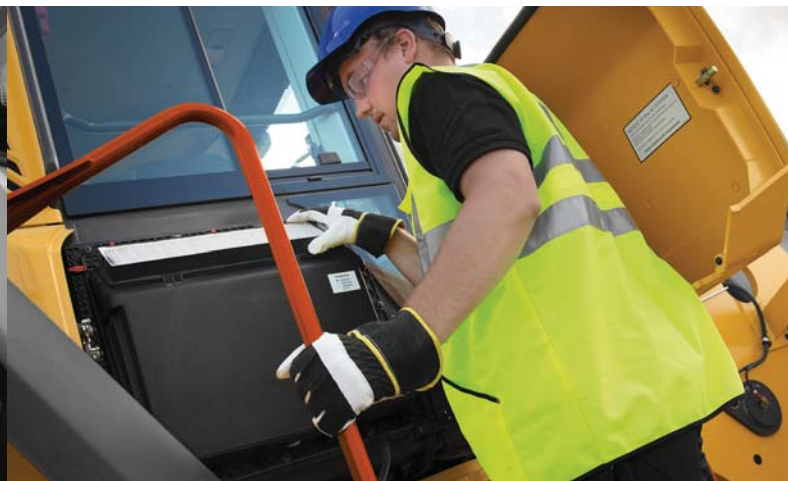

Single lever control

For ease of operation, the optional, multi-functional joystick gives the operator simultaneous and precise control of the hydraulic functions. Forward, reverse and kick-down functions are included on the console.

Cab suspension

The viscous cab suspension reduces vibration and noise, increasing operator comfort and performance. The spring added into the mounts also improves shock absorption to increase productivity.



Volvo cab

The spacious ROPS/FOPS certified cab provides a comfortable operating environment with ergonomically placed controls, ample storage space and a comfortable seat with three point seat belt and seat belt warning. With low internal noise levels and vibration protection, operators will experience a productive work shift.



Loaded with productivity.

Maximize your productivity and access more applications when you combine the new L150H, L180H and L220H with Volvo's durable attachments. Whether you're working in the rehandling, extraction, block-handling, recycling or any other application, these machines will effectively perform a variety of tasks and increase your productivity.

Boom Suspension System

The optional Boom Suspension System (BSS) boosts productivity by up to 20% by absorbing shock and reducing the bouncing and bucket spillage that occurs when operating on rough ground. This enables faster and more comfortable work cycles and increases machine life.

Rehandling solution

The combination of tires, Boom Suspension System and additional counterweight means that you can fit a larger rehandling bucket to the machine, resulting in increased productivity in rehandling applications.



TP Linkage
Volvo's unique Torque Parallel (TP) linkage delivers high breakout force and excellent parallel movement throughout the entire lifting range. This combined with the Volvo attachment bracket delivers greater machine flexibility and versatility.

Volvo attachments

Volvo's durable attachments have been purpose-built to work in perfect harmony with Volvo machines and increase your productivity. The attachments are designed as an integrated part of the wheel loader for which they're intended – with functions and properties ideally matched to parameters including link-arm geometry and breakout, rim pull and lifting force.

Special application options

With a wide variety of options, Volvo customers can adapt their machine to access more applications such as block handling, rock, quarry, slag handling and waste handling.

Revolutionary reliability.

Featuring a premium Volvo engine and perfectly matched drivetrain and hydraulics, the L150H, L180H and L220H wheel loaders deliver power, productivity and reliability. Experience Volvo's proven, advanced technology and benefit from ultimate quality and durability.

Volvo engine

Featuring advanced technology and built on decades of experience, the powerful Volvo engine delivers high performance and low fuel consumption. The water cooled turbocharger increases engine life and performance.



Cooling on demand

The hydraulically-driven, electronically controlled cooling fan regulates the temperature of the vital components. It automatically activates only when it's needed – reducing fuel consumption and noise. The optional reversible functionality – which blows air in the opposite direction – allows for self-cleaning of the cooling units.



Conronic and electronic systems

The machine's electronics support preventive maintenance and diagnostics for maximum uptime. Waterproof sealed connectors protect your machine's reliability and increase its longevity.

Axle oil circulation

Both the front and the rear axle feature an axle oil circulation feature, which allows the axle oil to circulate and cool inside the axle – protecting components. The optional axle oil cooling system cools axles and can reduce oil changing intervals.



Powertrain

The ideally-matched, all-Volvo powertrain has been built to work together in perfect harmony. The Volvo design has been rigorously tested to deliver optimized performance, high productivity, low fuel consumption and superior reliability. This long-established and proven technology has been built by Volvo for 40 years, including all in-house components and parts.

Easy access = more uptime.

Taking care of your wheel loader shouldn't be complicated. That's why the L150H, L180H and the L220H are loaded with time saving features. One example of this is the new tilting cab which significantly improves service and maintenance access to help you work for longer and sustain productivity day in and day out.

Maintenance-free batteries

Two heavy-duty, maintenance-free 12V batteries in series provide a 24V electrical system. The batteries are located in a well-sealed compartment on the right side of the machine.

Grouped and ground level greasing points

The ground level, grouped greasing points makes servicing and maintaining your machine quick and easy. The optional, automatic lubrication system controls greasing when the machine is in operation for more uptime and reduced maintenance.



Tilting cab

The cab can be tilted in two positions – 35° and 70°. Tilting the cab greatly improves service and maintenance access which leads to more uptime and increased machine availability. The cab is tilted via a manually operated pump.

Maintaining a smooth operation

Enjoy peace-of-mind for maximum machine uptime with the rear axle design. The sealed oscillation pins cradle keeps the grease in and the dirt out, keeping components greased for up to 8,000 hours so you can rely on reduced overall service time and costs.

Engine access

Electrically activated, the wide-opening engine hood allows quick and easy service access to the engine and components for maximum uptime.

Lift more with Volvo.



Tilting cab

The cab can be tilted in two positions – 30° and 70° – for improved service and maintenance access. This leads to more uptime and increased machine availability.



Volvo cab

Volvo's industry-leading, certified ROPS/FOPS cab features ergonomically placed controls, low internal noise levels, vibration protection and ample storage space.

Single lever

The optional, multi-functional joystick gives the operator simultaneous and precise control of the linkage.

Boom Suspension System (BSS)

The BSS boosts productivity by up to 20% by absorbing shock and reducing the bouncing and bucket spillage that occurs when operating at speed on rough terrain.



TP linkage

Volvo's unique Torque Parallel (TP) linkage delivers high breakout torque and excellent parallel movement through the entire lifting range.



OptiShift

Volvo's OptiShift technology reduces fuel consumption by up to 18%, increases operator comfort and reduces stress in the drivetrain.

Attachments

Volvo's durable attachments have been purpose-built to deliver maximum productivity and long service life in combination with Volvo machines.

Intelligent hydraulics

Volvo's load-sensing hydraulics supply power to the hydraulic functions according to demand, lowering fuel consumption.

APS/FAPS

Automatic Power Shift (APS) and Fully Automatic Power Shift (FAPS) ensure optimal operation by adjusting the machine gears automatically.

Easy service access

Electrically activated, wide-opening engine hood allows quick and easy service access to the engine compartment.

Volvo engine

The Volvo engine delivers high performance and low fuel consumption.



Powertrain

The ideally-matched, all-Volvo powertrain has been built to work together in perfect harmony – ensuring optimized performance.



Adding value to your business.

Being a Volvo customer means having a complete set of services at your fingertips. Volvo can offer you a long-term partnership, protect your revenue and provide a full range of customer solutions using high quality parts, delivered by passionate people. Volvo is committed to increasing the positive return on your investment and maximising uptime.



Complete Solutions

Volvo has the right solution for you. So why not let us provide all your needs throughout the whole life cycle of your machine? By listening to your requirements, we can reduce your total cost of ownership and increase your revenue.



CareTrack

CareTrack gives you access to a wide range of machine monitoring information designed to save you time and money. Reduce fuel costs, optimize machine and operator performance and proactively manage service and maintenance to maximize uptime.



Genuine Volvo Parts

Our attention to detail is what makes us stand out. This proven concept acts as a solid investment in your machine's future. Parts are extensively tested and approved because every part is vital for uptime and performance. Only by using Genuine Volvo Parts, can you be sure that your machine retains the renowned Volvo quality.



Service Network

In order to respond to your needs faster, a Volvo expert is on their way to your job site from one of our Volvo facilities. With our extensive infrastructure of technicians, workshops and dealers, Volvo has a comprehensive network to fully support you using local knowledge and global experience.



Customer Support Agreements

The range of Customer Support Agreements offer preventive maintenance, total repairs and a number of uptime services. Volvo uses the latest technology to monitor machine operation and status, giving you advice to increase your profitability. By having a Customer Support Agreement you are in control of your service costs.



Volvo L150H, L180H, L220H in detail.

Engine
 V-ACT Stage IIIA, 13 liter, 6-cylinder straight turbocharged diesel engine with 4 valves per cylinder, overhead camshaft and electronically controlled unit injectors. The engine has wet replaceable cylinder liners and replaceable valve guides and valve seats. The throttle applications is transmitted electrically from the throttle pedal or the optional hand throttle.
Air Cleaning: 2 stages.
Cooling system: Hydrostatic, electronically controlled fan and intercooler of the air-to-air type.

L150H		D13E
Engine		D13E
Max power at	r/s (r/min)	21.7 (1 300)
SAE J1995 gross	kW / hp	220 / 299
ISO 9249, SAE J1349 net	kW / hp	220 / 299
Max torque at	r/s (r/min)	16.7 (1 000)
SAE J1995 gross	Nm	1 960
ISO 9249, SAE J1349	Nm	1 957
Economic working range	r/min	800-1 600
Displacement	l	12.8

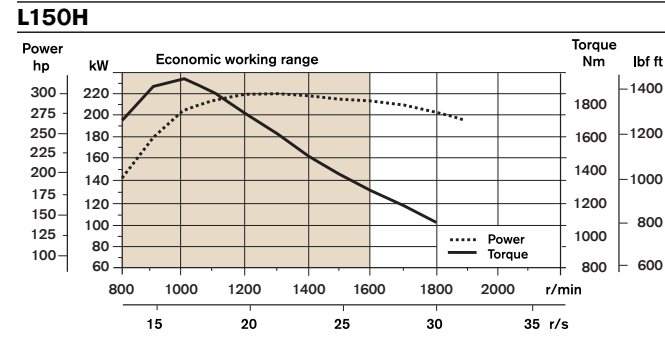

L180H		D13E
Engine		D13E
Max power at	r/s (r/min)	21.7-23.3 (1 300-1 400)
SAE J1995 gross	kW / hp	246 / 334
ISO 9249, SAE J1349 net	kW / hp	245 / 333
Max torque at	r/s (r/min)	16.7 (1 000)
SAE J1995 gross	Nm	2 030
ISO 9249, SAE J1349 net	Nm	2 024
Economic working range	r/min	800-1 600
Displacement	l	12.8

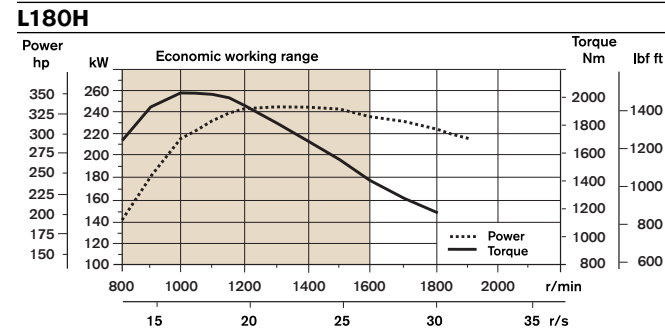

L220H		D13E
Engine		D13E
Max power at	r/s (r/min)	21.7-23.3 (1 300-1 400)
SAE J1995 gross	kW / hp	274 / 373
ISO 9249, SAE J1349 net	kW / hp	273 / 371
Max torque at	r/s (r/min)	18.3 (1 100)
SAE J1995 gross	Nm	2 231
ISO 9249, SAE J1349 net	Nm	2 220
Economic working range	r/min	800-1 600
Displacement	l	12.8

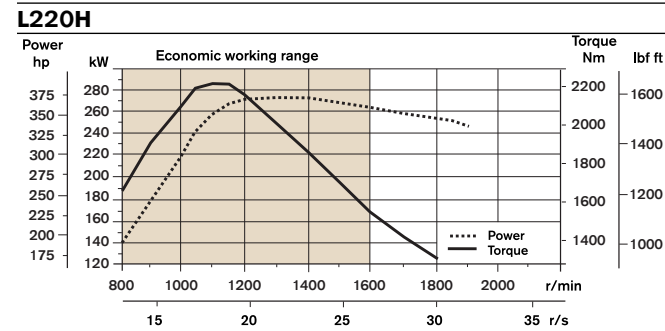

Drivetrain
Torque converter: Single-stage.
Transmission: Volvo countershaft transmission with single lever control. Fast and smooth shifting of gears with Pulse Width Modulation (PWM) valve. Torque converter with lockup.
Transmission: Volvo Automatic Power Shift (APS) with fully automatic shifting 1-4 and mode selector with 4 different gear shifting programs, including AUTO.
Axes: Volvo fully floating drive shafts with planetary hub reductions and nodular iron axle housing. Fixed front axle and oscillating rear axle. 100% differential lock on the front axle. Optional: Limslip rear

L150H		Volvo HTL 222C
Transmission		Volvo HTL 222C
1st gear	km/h	6.5
2nd gear	km/h	12.5
3rd gear	km/h	26
4th gear	km/h	38
Measured with tires		26.5 R25 L3
Front axle/rear axle		Volvo/AWB 40B/40C
Rear axle oscillation ±	°	15
Ground clearance at 15° osc.	mm	610

L180H		Volvo HTL 222C
Transmission		Volvo HTL 222C
1st gear	km/h	6.5
2nd gear	km/h	12.5
3rd gear	km/h	26
4th gear	km/h	38
Measured with tires		26.5 R25 L3
Front axle/rear axle		Volvo/AWB 40B/40B
Rear axle oscillation ±	°	15
Ground clearance at 15° osc.	mm	610

L220H		Volvo HTL 307B
Transmission		Volvo HTL 307B
1st gear	km/h	7
2nd gear	km/h	12
3rd gear	km/h	25.5
4th gear	km/h	38
Measured with tires		29.5 R25 L4
Front axle/rear axle		Volvo/AWB 50/41
Rear axle oscillation ±	°	15
Ground clearance at 15° osc.	mm	600

Electrical system
Central warning system: Contronic electrical system with central warning light and buzzer for following functions: - Serious engine fault - Low steering system pressure - Over speed warning engine - Interruption in communication (computer fault) Central warning light and buzzer with the gear engaged for the following functions: - Low engine oil pressure - High engine oil temperature - High charge air temperature - Low coolant level - High coolant temperature - High crank case pressure - Low transmission oil pressure - High transmission oil temperature - Low brake pressure - Engaged parking brake - Fault on brake charging - Low hydraulic oil level - High hydraulic oil temperature - Overspeeding in engaged gear - High brake cooling oil temperature front and rear axles.

Voltage	V	24
Batteries	V	2 x 12
Battery capacity	Ah	2 x 170
Cold cranking capacity, approx	A	1 000
Batteries		connected to postiv terminal
Alternator rating	W/A	2 280/80
Starter motor output	kW	7

Brake system
Service brake: Volvo dual-circuit system with nitrogen charged accumulators. Outboard mounted hydraulically operated, fully sealed oil circulation-cooled wet disc brakes. The operator can select automatic disengagement of the transmission when braking using Contronic.
Parking brake: Fully sealed, wet multi-disc brake built into the transmission. Applied by spring force and electro-hydraulically release dwith a switch on the instrument panel.
Secondary brake: Dual brake circuits with rechargeable accumulators. One circuit or the parking brake fulfills all safety requirements.
Standard: The brake system complies with the requirements of ISO 3450.

L150H		1/1
Number of brake discs per wheel front/rear		1/1
Accumulators	l	2x1.0 3x0.5

L180H		1/1
Number of brake discs per wheel front/rear		1/1
Accumulators	l	2x1.0 1x0.5

L220H		2/1
Number of brake discs per wheel front/rear		2/1
Accumulators	l	2x1.0 1x0.5

Cab
Instrumentation: All important information is centrally located in the operator's field of vision. Display for Contronic monitoring system.
Heater and defroster: Heater coil with filtered fresh air and fan with auto and 11 speeds. Defroster vents for all window areas.
Operator's seat: Operator's seat with adjustable suspension and retractable seatbelt. The seat is mounted on a bracket on the rear cab wall and floor. The forces from the retractable seatbelt are absorbed by the seat rails.
Standard: The cab is tested and approved according to ROPS (ISO 3471), FOPS (ISO 3449). The cab meets with requirements according to ISO 6055 (Operator overhead protection - Industrial trucks) and SAE J386 ("Operator Restraint System").

L150H		Use emergency hammer to break window
Emergency exit:		Use emergency hammer to break window
Sound level in cab according to ISO 6396/SAE J2105		
LpA	dB(A)	69
External sound level according to ISO 6395/SAE J2104		
LwA	dB(A)	108
Ventilation	m ³ /min	9
Heating capacity	kW	16
Air conditioning (optional)	kW	7.5

L180H		Use emergency hammer to break window
Emergency exit:		Use emergency hammer to break window
Sound level in cab according to ISO 6396/SAE J2105		
LpA	dB(A)	70
External sound level according to ISO 6395/SAE J2104		
LwA	dB(A)	108
Ventilation	m ³ /min	9
Heating capacity	kW	16
Air conditioning (optional)	kW	7.5

L220H		Use emergency hammer to break window
Emergency exit:		Use emergency hammer to break window
Sound level in cab according to ISO 6396/SAE J2105		
LpA	dB(A)	70
External sound level according to ISO 6395/SAE J2104		
LwA	dB(A)	109
Ventilation	m ³ /min	9
Heating capacity	kW	16
Air conditioning (optional)	kW	7.5

Volvo L150H, L180H, L220H in detail.

Lift arm system			
Torque Parallel linkage (TP-linkage) with high breakout torque and parallel action throughout the entire lifting range.			
	L150H	L180H	L220H
Lift cylinders	2	2	2
Cylinder bore	mm 160	180	190
Piston rod diameter	mm 90	90	90
Stroke	mm 784	788	768
Tilt cylinder	1	1	1
Cylinder bore	mm 220	240	250
Piston rod diameter	mm 110	120	120
Stroke	mm 452	480	455
Hydraulic system			
System supply: Two load-sensing axial piston pumps with variable displacement. The steering function always has priority.			
Valves: Double-acting 2-spool valve. The main valve is electro operated.			
Lift function: The valve has four positions; raise, hold, lower and floating position. Inductive/magnetic automatic boom kickout can be switched on and off and is adjustable to any position between maximum reach and full lifting height.			
Tilt function: The valve has three functions including rollback, hold and dump. Inductive/magnetic automatic tilt can be adjusted to the desired bucket angle.			
Cylinders: Double-acting cylinders for all functions.			
Filter: Full flow filtration through 10 micron (absolute) filter cartridge.			
	L150H	L180H	L220H
Working pressure maximum, pump 1	MPa 29	29	29
Flow at engine speed	l/min 180	217	253
Working pressure maximum, pump 2	MPa 31	31	31
Flow at engine speed	l/min 202	202	202
Working pressure maximum, pump 3	MPa 25	25	25
Flow at engine speed	l/min 77	77	77
Pilot system, working pressure	MPa 3.5	3.5	3.5
Cycle times			
Lift	s 5.9	6.4	6.8
Tilt	s 2	1.8	1.6
Lower, empty	s 3.7	3.3	3.2
Total cycle time	s 11.6	11.5	11.6

Steering system			
Steering system: Load-sensing hydrostatic articulated steering.			
System supply: The steering system has priority feed from a load-sensing axial piston pump with variable displacement.			
Steering cylinders: Two double-acting cylinders.			
	L150H	L180H	L220H
Steering cylinders	2	2	2
Cylinder bore	mm 100	100	100
Rod diameter	mm 60	60	60
Stroke	mm 390	525	525
Working pressure	MPa 21	21	21
Maximum flow	l/min 188	188	191
Maximum articulation	± ° 37	37	37
Stroke	mm 452	480	455
Service			
Service accessibility: Large, easy-to-open hood covering whole engine department, electrically operated. Fluid filters and component breather air filters promote long service intervals. Possibility to monitor, log and analyze data to facilitate troubleshooting.			
	L150H	L180H	L220H
Fuel Tank	l 366	366	366
Engine coolant	l 55	55	55
Hydraulic oil tank	l 156	156	226
Transmission oil	l 48	48	48
Engine oil	l 50	50	50
Axle oil front/rear	l 46/55	46/55	77/71

Specifications.

Tires L150H, L180H: 26.5 R25 L3. Tires L220H: 29.5 R25 L3							
		Standard boom			Long boom		
		L150H	L180H	L220H	L150H	L180H	L220H
B	mm	7 070	7 190	7 480	7 570	7 620	7 800
C	mm	3 550	3 550	3 700	3 550	3 550	3 700
D	mm	480	480	530	470	490	530
F	mm	3 580	3 580	3 730	3 570	3 590	3 730
G	mm	2 134	2 134	2 135	2 157	2 133	2 133
J	mm	3 920	4 060	4 230	4 490	4 560	4 600
K	mm	4 340	4 470	4 660	4 900	4 970	5 020
O	°	58	57	56	59	55	56
Pmax	°	50	49	48	49	49	48
R	°	45	45	43	48	48	44
R [*]	°	48	48	47	53	53	49
S	°	66	71	65	61	63	63
T	mm	93	131	119	149	207	121
U	mm	520	570	600	640	660	680
X	mm	2 280	2 280	2 400	2 280	2 280	2 400
Y	mm	2 960	2 960	3 150	2 960	2 960	3 150
Z	mm	3 510	3 810	4 050	3 960	4 180	4 380
a ₂	mm	6 790	6 790	7 100	6 790	6 790	7 100
a ₃	mm	3 820	3 820	3 960	3 820	3 820	3 960
a ₄	± °	37	37	37	37	37	37

* Carry position SAE

Bucket: L150H: 4.0 m³ GP STE P T SEG
L180H: 4.6 m³ GP STE P T SEG
L220H: 5.2 m³ GP STE P T SEG

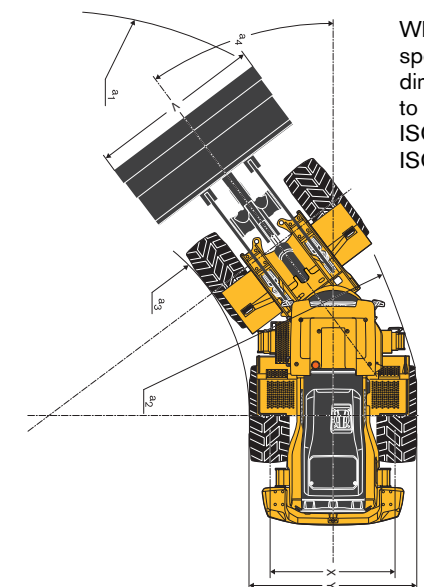
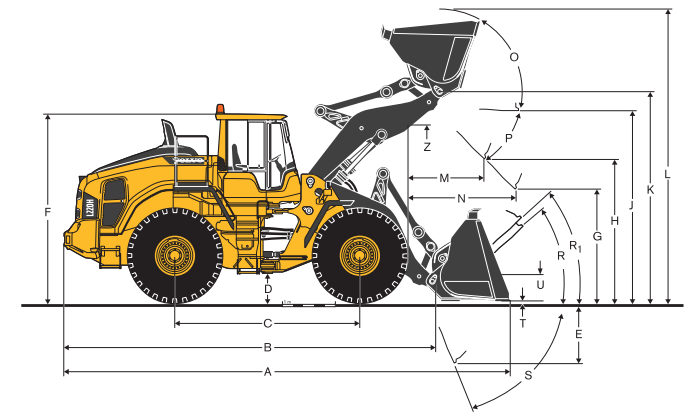

Where applicable, specifications and dimensions are according to ISO 7131, SAE J732, ISO 7546, SAE J742, ISO 14397, SAE J818.

- L150H** Sales code: WLA80713
Operating weight (incl. logging cw 1 140 kg): 25 660 kg
Operating load: 7 700 kg
- L180H** Sales code: WLA80027
Operating weight (incl. logging cw 1 140 kg): 28 470 kg
Operating load: 8 710 kg
- L220H** Sales code: WLA80852
Operating weight (incl. logging cw 870 kg): 32 810 kg
Operating load: 10 080 kg

Tires L150H, L180H: 775/65 R29 L3 Tires L220H: 875/65 R29 L4				
		L150H	L180H	L220H
A	m ²	3.1	3.5	4
B	mm	3 660	3 870	3 920
C	mm	2 110	2 150	2 270
D	mm	2 960	3 150	3 160
E	mm	1 650	1 720	1 780
F	mm	1 630	1 700	1 640
G	mm	2 930	3 040	3 230
H	mm	4 990	5 170	5 350
I	mm	7 270	7 610	7 730
J	mm	3 080	3 370	3 620
K	mm	3 340	3 710	3 940
L	mm	2 290	2 410	2 630
M	mm	9 680	9 980	10 380

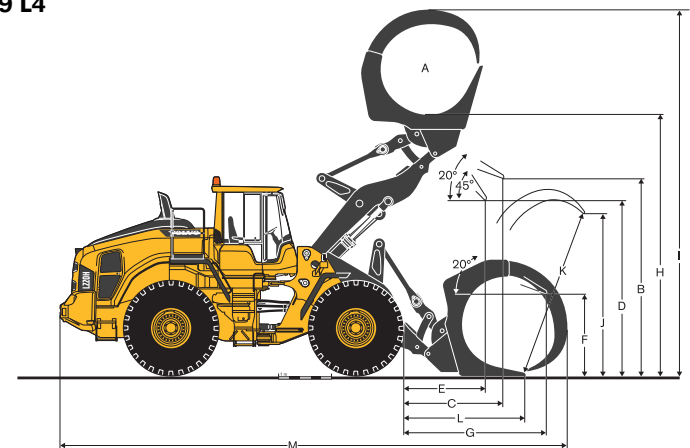

Specifications.

L150H											
Tires 26.5 R25 L3	REHANDLING				GENERAL PURPOSE			ROCK***	LIGHT MATERIAL	LONG BOOM*	
Volume, heaped ISO/SAE	m³	4.0	4.4	4.8	5.2	4.0	4.4	4.5	3.5	6.8	-
Volume at 110% fill factor	m³	4.4	4.8	5.3	5.7	4.4	4.8	5.0	3.9	7.5	-
Static tipping load, straight	kg	20 500	20 230	19 950	19 800	18 100	17 690	17 670	18 730	16 360	-3 550
at 35° turn	kg	18 320	18 050	17 780	17 630	16 190	15 780	15 760	16 730	14 520	-3 270
at full turn	kg	18 070	17 810	17 530	17 380	15 970	15 560	15 550	16 500	14 310	-3 230
Breakout force	kN	201.3	191.7	183.2	182.7	202	192	184	188.0	140.0	9
A	mm	8 600	8 680	8 750	8 750	8 790	8 860	8 930	8 850	9 230	520
E	mm	1 230	1 300	1 360	1 370	1 400	1 460	1 520	1 450	1 790	10
H**)	mm	3 020	2 970	2 920	2 920	2 890	2 850	2 800	2 870	2 620	570
L	mm	5 720	5 770	5 880	5 870	5 880	5 990	6 040	5 970	6 140	570
M**)	mm	1 220	1 270	1 320	1 320	1 360	1 410	1 450	1 420	1 700	-20
N**)	mm	1 800	1 830	1 860	1 860	1 880	1 910	1 930	1 930	1 960	450
V	mm	3 200	3 200	3 200	3 400	3 230	3 200	3 000	3 230	3 200	0
a ₁ clearance circle	mm	14 640	14 670	14 700	14 890	14 750	14 760	14 600	14 800	14 940	340
Operating weight	kg	25 090	25 300	25 500	25 620	24 090	24 450	24 420	25 320	24 920	410

*) Measured with 4.0 m³ GP STE P T SEG bucket Note: This only applies to genuine Volvo attachments.
 **) Measured to the tip of the bucket teeth or bolt-on edge. Dump height to bucket edge measured at 45° dump angle. (Spade nose buckets at 42°.)
 ***) Measured with 26.5 R25 L5 tires

Bucket Selection Chart

The chosen bucket is determined by the density of the material and the expected bucket fill factor. The actual bucket volume is often larger than the rated capacity, due to the features of the TP linkage, including an open bucket design, good rollback angles in all positions and good bucket filling performance. The example represents a standard boom configuration.
 Example: Sand and gravel. Fill factor ~ 105%. Density 1.6 t/m³.
 Result: The 4.0 m³ bucket carries 4.2 m³. For optimum stability always consult the bucket selection chart.

Material	Bucket fill, %	Material density, t/m³	ISO/SAE bucket volume, m³	Actual volume, m³
Earth/Clay	~ 110	~ 1.6	4.0	~ 4.4
		~ 1.5	4.4	~ 4.8
Sand/Gravel	~ 105	~ 1.6	4.0	~ 4.2
		~ 1.5	4.4	~ 4.6
Aggregate	~ 100	~ 1.8	4.4	~ 4.4
		~ 1.7	4.8	~ 4.8
		~ 1.5	5.2	~ 5.2
Rock	≤100	~ 1.7	3.5	~ 3.5

The size of rock buckets is optimized for optimal penetration and filling capability rather than the density of the material.

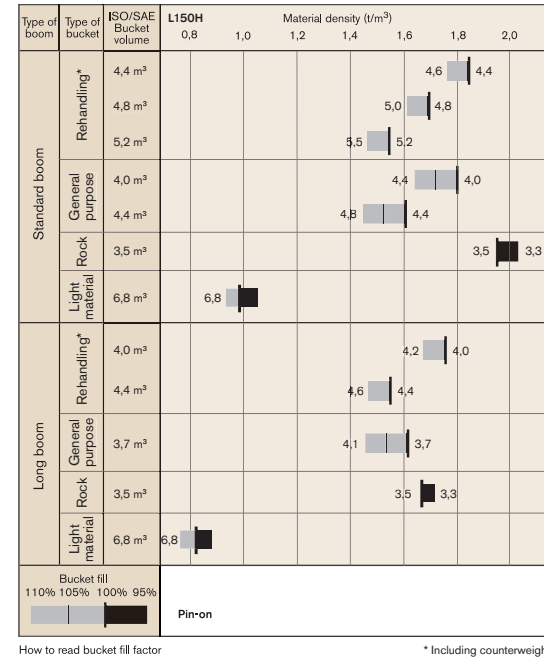

Supplemental Operating Data

Tires 26.5 R25 L3	Standard boom			Long boom			
	26.5 R25 L4	26.5 R25 L5	775/65 R29 L3	26.5 R25 L4	26.5 R25 L5	775/65 R29 L3	
Width over tires	mm	+5	+30	+180	+5	+30	+180
Ground clearance	mm	+18	+30	+10	+18	+30	+10
Tipping load, full turn	kg	+250	+760	+590	+220	+640	+500
Operating weight	kg	+400	+1 060	+760	+400	+1 050	+750

L180H											
Tires 26.5 R25 L3	REHANDLING				GENERAL PURPOSE			ROCK***	LIGHT MATERIAL	LONG BOOM*	
Volume, heaped ISO/SAE	m³	4.8	5.2	5.5	5.8	4.4	4.6	4.8	4.2	7.8	-
Volume at 110% fill factor	m³	5.3	5.7	6.1	6.4	4.8	5.1	5.3	4.6	8.6	-
Static tipping load, straight	kg	23 670	23 520	23 350	23 210	21 540	21 560	21 360	22 250	20 430	-3 820
at 35° turn	kg	21 010	20 860	20 700	20 570	19 140	19 150	18 960	19 750	18 070	-3 480
at full turn	kg	20 710	20 560	20 390	20 260	18 860	18 880	18 690	19 470	17 800	-3 450
Breakout force	kN	224.9	224.2	216.2	210.0	235.9	236.0	226.4	212.6	173.5	3.9
A	mm	8 890	8 890	8 960	9 010	9 000	9 000	9 070	9 140	9 360	470
E	mm	1 430	1 430	1 490	1 540	1 530	1 530	1 590	1 650	1 860	20
H**)	mm	3 060	3 050	3 010	2 970	2 990	2 990	2 940	2 910	2 690	500
L	mm	6 010	6 010	6 040	6 110	6 130	6 170	6 180	6 320	6 300	500
M**)	mm	1 330	1 330	1 370	1 410	1 420	1 420	1 460	1 520	1 610	20
N**)	mm	1 960	1 960	1 990	2 000	2 020	2 020	2 040	2 080	2 050	410
V	mm	3 200	3 400	3 400	3 400	3 200	3 200	3 200	3 230	3 400	-
a ₁ clearance circle	mm	14 800	14 990	15 010	15 040	14 850	14 850	14 880	14 960	15 220	-
Operating weight	kg	28 070	28 190	28 290	28 360	27 020	27 060	27 120	28 440	27 470	270

*) Measured with 4.6 m³ GP STE P T SEG bucket Note: This only applies to genuine Volvo attachments.
 **) Measured to the tip of the bucket teeth or bolt-on edge. Dump height to bucket edge measured at 45° dump angle. (Spade nose buckets at 42°.)
 ***) Measured with 26.5 R25 L5 tires

Bucket Selection Chart

The chosen bucket is determined by the density of the material and the expected bucket fill factor. The actual bucket volume is often larger than the rated capacity, due to the features of the TP linkage, including an open bucket design, good rollback angles in all positions and good bucket filling performance. The example represents a standard boom configuration.
 Example: Sand and gravel. Fill factor ~ 105%. Density 1.6 t/m³.
 Result: The 4.6 m³ bucket carries 4.8 m³. For optimum stability always consult the bucket selection chart.









Material	Bucket fill, %	Material density, t/m³	ISO/SAE bucket volume, m³	Actual volume, m³
Earth/Clay	~ 110	~ 1.7	4.4	~ 4.8
		~ 1.6	4.6	~ 5.1
		~ 1.5	4.8	~ 5.3
Sand/Gravel	~ 105	~ 1.7	4.4	~ 4.6
		~ 1.6	4.6	~ 4.8
		~ 1.5	4.8	~ 5.1
Aggregate	~ 100	~ 1.8	5.2	~ 5.2
		~ 1.7	5.5	~ 5.5
		~ 1.6	5.8	~ 5.8
Rock	≤100	~ 1.7	4.3	~ 4.3

The size of rock buckets is optimized for optimal penetration and filling capability rather than the density of the material.

Supplemental Operating Data

Tires 26.5 R25 L3	Standard boom			Long boom			
	26.5 R25 L4	26.5 R25 L5	775/65 R29 L3	26.5 R25 L4	26.5 R25 L5	775/65 R29 L3	
Width over tires	mm	+5	+30	+130	+5	+30	+130
Ground clearance	mm	+18	+40	+10	+18	+40	+10
Tipping load, full turn	kg	+280	+770	+600	+250	+760	+530
Operating weight	kg	+400	+1 050	+920	+400	+1 050	+1 120

Specifications.

L220H											
Tires 29.5 R25 L3	REHANDLING				GENERAL PURPOSE			ROCK***	LIGHT MATERIAL	LONG BOOM*	
	 5.6 m³ STE P BOE	 5.9 m³ STE P BOE	 6.3 m³ STE P BOE	 4.9 m³ STE P T SEG	 5.2 m³ STE P T SEG	 5.6 m³ STE P T SEG	 4.5 m³ SPN P T SEG	 5.0 m³ SPN P T SEG	 8.2 m³ LM P		
Volume, heaped ISO/SAE	m³	5.6	5.9	6.3	4.9	5.2	5.6	4.5	5.0	8.2	-
Volume at 110% fill factor	m³	6.2	6.5	6.9	5.4	5.7	6.2	5.0	5.5	9.0	-
Static tipping load, straight	kg	25 270	25 140	24 960	23 960	23 900	23 600	24 900	23 770	22 820	-2 890
at 35° turn	kg	22 420	22 290	22 120	21 280	21 220	20 940	22 150	21 090	20 190	-2 650
at full turn	kg	22 090	21 970	21 800	20 980	20 910	20 630	21 840	20 780	19 890	-2 620
Breakout force	kN	228.9	223.1	215.0	255.9	244.5	229.0	211.5	196.5	190.8	3.4
A	mm	9 270	9 310	9 380	9 310	9 350	9 460	9 580	9 730	9 580	310
E	mm	1 470	1 510	1 570	1 510	1 540	1 640	1 730	1 860	1 750	-30
H**)	mm	3 160	3 130	3 080	3 130	3 110	3 040	3 030	2 930	2 910	370
L	mm	6 260	6 290	6 370	6 370	6 440	6 440	6 450	6 510	6 450	360
M**)	mm	1 400	1 440	1 480	1 430	1 470	1 560	1 700	1 800	1 610	-30
N**)	mm	2 100	2 120	2 150	2 120	2 160	2 200	2 250	2 300	2 180	270
V	mm	3 400	3 400	3 400	3 430	3 400	3 400	3 430	3 430	3 700	-
a ₁ clearance circle	mm	15 570	15 590	15 620	15 610	15 610	15 670	15 770	15 850	16 020	-
Operating weight	kg	31 950	32 020	32 130	31 160	31 190	31 260	32 710	33 130	31 660	380

*) Measured with 5.2 m³ GP STE P T SEG bucket

Note: This only applies to genuine Volvo attachments.

** Measured to the tip of the bucket teeth or bolt-on edge. Dump height to bucket edge measured at 45° dump angle. (Spade nose buckets at 42°.)

*** Measured with 29.5 R25 L5 tires

Bucket Selection Chart

The chosen bucket is determined by the density of the material and the expected bucket fill factor. The actual bucket volume is often larger than the rated capacity, due to the features of the TP linkage, including an open bucket design, good rollback angles in all positions and good bucket filling performance. The example represents a standard boom configuration.

Example: Sand and gravel. Fill factor ~ 105%. Density 1.6 t/m³.
Result: The 5.2 m³ bucket carries 5.5 m³. For optimum stability always consult the bucket selection chart.

Material	Bucket fill, %	Material density, t/m³	ISO/SAE bucket volume, m³	Actual volume, m³
Earth/Clay	~ 110	~ 1.6	4.9	~ 5.4
		~ 1.5	5.2	~ 5.7
		~ 1.4	5.4	~ 5.9
Sand/Gravel	~ 105	~ 1.7	4.9	~ 5.1
		~ 1.6	5.2	~ 5.5
		~ 1.5	5.4	~ 5.7
Aggregate	~ 100	~ 1.8	5.6	~ 5.6
		~ 1.7	5.9	~ 5.9
		~ 1.6	6.3	~ 6.3
Rock	≤ 100	~ 1.7	4.5	~ 4.5

The size of rock buckets is optimized for optimal penetration and filling capability rather than the density of the material.

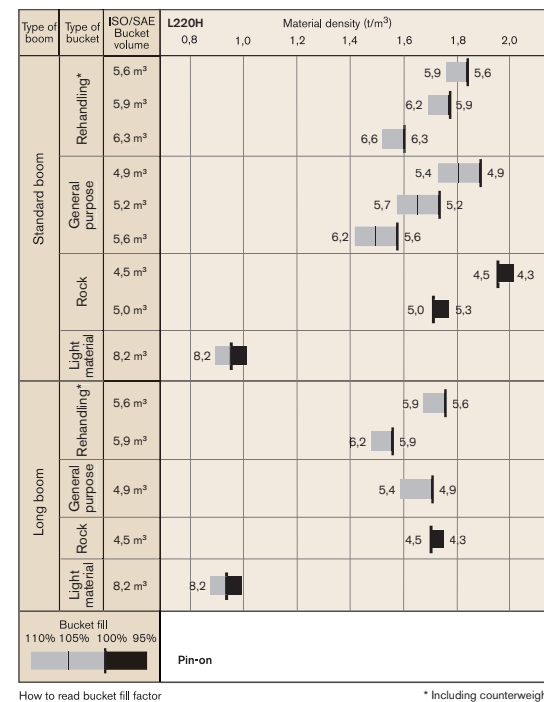

Supplemental Operating Data

	Tires 29.5 R25 L4	Standard boom			Long boom		
		29.5 R25 L3	29.5 R25 L5	875/65 R29 L4	29.5 R25 L3	29.5 R25 L5	875/65 R29 L4
Width over tires	mm	-20	+35	+95	-20	+35	+95
Ground clearance	mm	±0	+40	-10	±0	+40	-20
Tipping load, full turn	kg	-100	+1 010	+180	-90	+930	+180
Operating weight	kg	-80	+1 490	+650	-80	+1 500	+650

Equipment.

STANDARD EQUIPMENT

	L150H	L180H	L220H
Service and maintenance			
Engine oil remote drain and fill	•	•	•
Transmission oil remote drain and fill	•	•	•
Lubrication manifolds, ground accessible	•	•	•
Pressure check connections: transmission and hydraulic, quick-connects	•	•	•
Tool box, lockable	•	•	•
Engine			
Three stage air cleaner, pre-cleaner, primary and secondary filter	•	•	•
Two stage air cleaner, pre-cleaner, primary and secondary filter	•	•	•
Indicator for coolant level	•	•	•
Preheating of induction air	•	•	•
Fuel pre-filter with water trap	•	•	•
Fuel filter	•	•	•
Crankcase breather oil trap	•	•	•
Exterior radiator air intake protection	•	•	•
Electrical system			
24 V, pre-wired for optional accessories	•	•	•
Alternator 24V/80A/2280W	•	•	•
Battery disconnect switch	•	•	•
Fuel gauge	•	•	•
Hour meter	•	•	•
Electric horn	•	•	•
Instrument cluster:			
Fuel level	•	•	•
Diesel Exhaust Fluid/AdBlue level	•	•	•
Transmission temperature	•	•	•
Coolant temperature	•	•	•
Instrument lighting	•	•	•
Lighting:			
Twin halogen front headlights with high and low beams	•	•	•
Parking lights	•	•	•
Double brake and tail lights	•	•	•
Turn signals with flashing hazard light function	•	•	•
Halogen work lights (2 front and 2 rear)	•	•	•
Contronic monitoring system			
Monitoring and logging of machine data	•	•	•
Contronic display	•	•	•
Fuel consumption	•	•	•
Diesel Exhaust Fluid/AdBlue consumption	•	•	•
Ambient temperature	•	•	•
Clock	•	•	•
Test function for warning and indicator lights	•	•	•
Brake test	•	•	•
Test function, sound level at max fan speed	•	•	•
Warning and indicator lights:			
Battery charging	•	•	•
Parking brake	•	•	•
Warning and display message:			
Regeneration	•	•	•
Engine coolant temperature	•	•	•
Charge-air temperature	•	•	•
Engine oil temperature	•	•	•
Engine oil pressure	•	•	•
Transmission oil temperature	•	•	•
Transmission oil pressure	•	•	•
Hydraulic oil temperature	•	•	•
Brake pressure	•	•	•
Parking brake applied	•	•	•
Brake charging	•	•	•
Overspeed at direction change	•	•	•
Axle oil temperature	•	•	•
Steering pressure	•	•	•
Crankcase pressure	•	•	•
Attachment lock open	•	•	•
Safety Belt Warning	•	•	•
Level warnings:			
Fuel level	•	•	•
Diesel Exhaust Fluid/AdBlue level	•	•	•
Engine oil level	•	•	•
Engine coolant level	•	•	•
Transmission oil level	•	•	•
Hydraulic oil level	•	•	•
Washer fluid level	•	•	•
Engine torque reduction in case of malfunction indication:			
High engine coolant temperature	•	•	•
High engine oil temperature	•	•	•
Low engine oil pressure	•	•	•
High crankcase pressure	•	•	•
High charge-air temperature	•	•	•
Engine shutdown to idle in case of malfunction indication:			
High transmission oil temperature	•	•	•
Slip in transmission clutches	•	•	•
Keypad, background lit	•	•	•
Start interlock when gear is engaged	•	•	•

	L150H	L180H	L220H
Drivetrain			
Automatic Power Shift	•	•	•
Fully automatic gearshifting, 1-4	•	•	•
PWM-controlled gearshifting	•	•	•
Forward and reverse switch by hydraulic lever console	•	•	•
Indicator glass for transmission oil level	•	•	•
Differentials: Front, 100% hydraulic diff lock. Rear, conventional.	•	•	•
OptiShift	•	•	•
Lock-up first gear	•	•	•
Brake system			
Dual brake circuits	•	•	•
Dual brake pedals	•	•	•
Secondary brake system	•	•	•
Parking brake, electro-hydraulic	•	•	•
Brake wear indicators	•	•	•
Cab			
ROPS (ISO 3471), FOPS (ISO 3449)	•	•	•
Single key kit door/start	•	•	•
Acoustic inner lining	•	•	•
Cigarette lighter, 24 V power outlet	•	•	•
Lockable door	•	•	•
Cab heating with fresh air inlet and defroster	•	•	•
Fresh air inlet with two filters	•	•	•
Automatic heat control	•	•	•
Floor mat	•	•	•
Dual interior lights	•	•	•
Interior rear-view mirrors	•	•	•
Dual exterior rear-view mirrors	•	•	•
Sliding window, right side	•	•	•
Tinted windshield glass	•	•	•
Retractable seatbelt (SAE J386)	•	•	•
Adjustable steering wheel	•	•	•
Storage compartment	•	•	•
Document pocket	•	•	•
Sun visor	•	•	•
Beverage holder	•	•	•
Windshield washer front and rear	•	•	•
Windshield wipers front and rear	•	•	•
Interval function for front and rear wipers	•	•	•
Hydraulic system			
Main valve, double acting 2-spool with hydraulic pilots	•	•	•
Variable displacement axial piston pumps (3) for:			
1 Working hydraulics, Pilot hydraulics and Brake system	•	•	•
2 Working hydraulics, Pilot hydraulics, Steering and Brake system	•	•	•
3 Cooling fan and Brake system	•	•	•
Electro-hydraulic servo controls	•	•	•
Electronic hydraulic lever lock	•	•	•
Automatic boom kick-out	•	•	•
Automatic bucket positioner	•	•	•
Double-acting hydraulic cylinders	•	•	•
Indicator glass for hydraulic oil level	•	•	•
Hydraulic oil cooler	•	•	•
External equipment			
Orange hand rails	•	•	•
Fenders, front and rear	•	•	•
Viscous cab mounts	•	•	•
Rubber engine and transmission mounts	•	•	•
Frame, joint lock	•	•	•
Vandalism lock prepared for	•	•	•
Engine compartment	•	•	•
Radiator grille	•	•	•
Lifting eyes	•	•	•
Tie-down eyes	•	•	•
Fabricated counterweight	•	•	•
Counterweight, pre-drilled for optional guards	•	•	•

Equipment.

OPTIONAL EQUIPMENT

	L150H	L180H	L220H
Service and maintenance			
Automatic lubrication system	•	•	•
Automatic lubrication system for long boom	•	•	•
Grease nipple guards	•	•	•
Oil sampling valve	•	•	•
Refill pump for grease to lube system	•	•	•
Tool kit	•	•	•
Wheel nut wrench kit	•	•	•
CareTrack, GSM, GSM/Satellite	•	•	•
Telematics, Subscription	•	•	•
Engine			
Air pre-cleaner, cyclone type	•	•	•
Air pre-cleaner, oil-bath type	•	•	•
Air pre-cleaner, turbo type	•	•	•
Engine auto shutdown	•	•	•
Engine block heater 230V/110V	•	•	•
Fuel fill strainer	•	•	•
Fuel heater	•	•	•
Hand throttle control	•	•	•
Max. fan speed, hot climate	•	•	•
Radiator, corrosion-protected	•	•	•
Reversible cooling fan	•	•	•
Reversible cooling fan and axle oil cooler	•	•	•
Electrical system			
Anti-theft device	•	•	•
Emergency stop	•	•	•
Locking device, Tag out Lock out	•	•	•
Headlights, assym. left	•	•	•
License plate holder, lighting	•	•	•
Rear vision system, colour LCD monitor in the cab	•	•	•
Rear view mirrors, Long arm	•	•	•
Rear view mirrors, adjustable, el.heated, Long arm	•	•	•
Reduced function working lights, reverse gear activated	•	•	•
Reverse alarm, audible	•	•	•
Reverse alarm, audible, multi-frequency	•	•	•
Reverse warning light, strobe lighting	•	•	•
Shortened headlight support brackets	•	•	•
Side marker lamps	•	•	•
Warning beacon LED	•	•	•
Working lights halogen, attachments	•	•	•
Working lights LED, attachments	•	•	•
Working lights on cab halogen, front and rear	•	•	•
Working lights on cab halogen, rear	•	•	•
LED Head Light	•	•	•
Working lights, on cab LED, front and rear	•	•	•
Working lights, on cab LED, rear	•	•	•
Working lights, rear in grille, 2 LED lamps	•	•	•
Working lights, front above head lamps, 2 LED lamps	•	•	•
Taillight, LED lamp	•	•	•
Electrical distribution unit 24 volt	•	•	•
Load Assist	•	•	•
Radar detect system	•	•	•
Jump start connector, NATO-Type	•	•	•

	L150H	L180H	L220H
Cab			
Anchorage for Operator's manual	•	•	•
Automatic Climate Control, ACC	•	•	•
ACC control panel, with Fahrenheit scale	•	•	•
Asbestos dust protection filter	•	•	•
Ashtray	•	•	•
Cab air pre-cleaner, cyclone type	•	•	•
Carbon filter	•	•	•
Cover plate, under cab	•	•	•
Lunch box holder	•	•	•
Volvo Armrest, operator's seat, left	•	•	•
Operator's seat, Volvo air susp, heavy-duty, high back, heated	•	•	•
Operator's seat, (air seat std) 2-point seat belt	•	•	•
Operator's seat, (air seat std) 3-point seat belt	•	•	•
Radio installation kit incl. 12 volt outlet, left side	•	•	•
Radio installation kit incl. 12 volt outlet, right side	•	•	•
Radio (with AUX, Bluetooth and USB connection)	•	•	•
Subwoofer	•	•	•
Steering wheel knob	•	•	•
Sun blinds, rear windows	•	•	•
Sun blinds, side windows	•	•	•
Timer cab heating	•	•	•
Window, sliding, door	•	•	•
Universal door/ignition key	•	•	•
Remote door opener	•	•	•
Forward view mirror	•	•	•
Cab heater power outlet 240V	•	•	•
Drivetrain			
OptiShift transmission with Lock-up RBB	•	•	•
Diff lock front 100%, Limited Slip rear	•	•	•
Speed limiter	•	•	•
Wheel/axle seal guards	•	•	•
Brake system			
Oil cooler and filter front & rear axle	•	•	•
Stainless steel, brake lines	•	•	•
Hydraulic system			
Boom suspension system	•	•	•
Separate attachment locking	•	•	•
Arctic kit, attachment locking hoses	•	•	•
Arctic kit, for 3rd function	•	•	•
Boom cylinder hose and tube guards	•	•	•
Hydraulic fluid, biodegradable, Volvo	•	•	•
Hydraulic fluid, fire-resistant	•	•	•
Hydraulic fluid, for hot climate	•	•	•
Hydraulic 3rd function	•	•	•
hydraulic 3rd-4th function	•	•	•
Hydraulic Constant Flow Control with detent for 3rd function	•	•	•
Single lever control, hydraulics 2 functions	•	•	•
Single lever control, hydraulics 3 functions	•	•	•
Single lever control, hydraulics 4 functions	•	•	•
External equipment			
Cab ladder, rubber-suspended	•	•	•
Deleted front mudguards	•	•	•
Fire suppression system	•	•	•
Mudguards, full cover, front and rear for 80-series tires	•	•	•
Mudguards, full cover, front and rear for 65-series tires	•	•	•
Mudguards, full cover wideners and prot. Included	•	•	•
Long boom	•	•	•
Tow hitch	•	•	•

	L150H	L180H	L220H
Protective equipment			
Belly guard front	•	•	•
Belly guard rear	•	•	•
Cover plate, heavy-duty, front frame	•	•	•
Cover plate, rear frame	•	•	•
Cover plate, front/rear axle	•	•	•
Cab roof, heavy-duty	•	•	•
Guards for front headlights	•	•	•
Guards for radiator grill	•	•	•
Guards for tail lights	•	•	•
Windows, side and rear guards	•	•	•
Windshield guard	•	•	•
Corrosion protection, painting of machine	•	•	•
Corrosion protection, painting of attachment bracket	•	•	•
Bucket Teeth protection	•	•	•
Other equipment			
CE-marking	•	•	•
Comfort Drive Control (CDC)	•	•	•
Counterweight, logging	•	•	•
Counterweight, signal painted, chevrons	•	•	•
Secondary steering with automatic test function	•	•	•
Sound decal, EU	•	•	•
Sound decal, USA	•	•	•
Reflecting stickers (decals), machine contour	•	•	•
Reflecting stickers (stripes), machine contour Cab	•	•	•
Noise reduction kit, exterior	•	•	•
Sign, slow moving vehicle	•	•	•
Sign, 50 km/h	•	•	•
Tires			
26.5 R25	•	•	•
775/65 R29	•	•	•
29.5 R25	•	•	•
875/65 R29	•	•	•
Attachments			
Buckets:			
Rock straight or spade nose	•	•	•
General purpose	•	•	•
Re-handling	•	•	•
Side-dump	•	•	•
Light material	•	•	•
Wear parts:			
Bolt-on and weld-on bucket teeth	•	•	•
Segments	•	•	•
Cutting edge in three sections, bolt-on	•	•	•
Fork equipment	•	•	•
Material handling arm	•	•	•
Log grapples	•	•	•

SELECTION OF VOLVO OPTIONAL EQUIPMENT

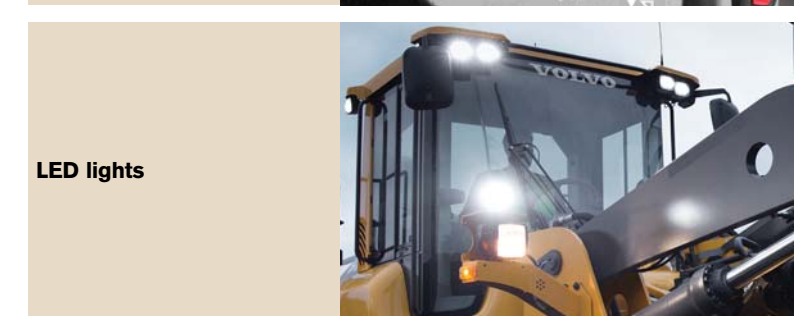
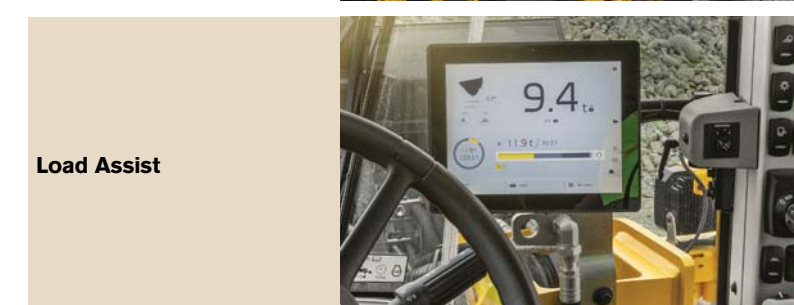
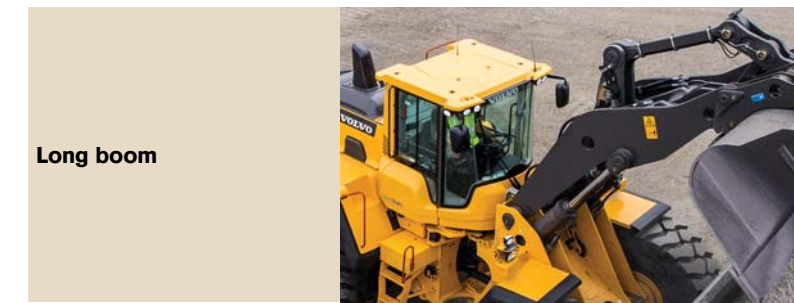

Not all products are available in all markets. Under our policy of continuous improvement, we reserve the right to change specifications and design without prior notice. The illustrations do not necessarily show the standard version of the machine.



BIG ENOUGH TO TRUST SMALL ENOUGH TO CARE

Founded in 1974 CJD Equipment are in the industry for the long term and have the skills and knowledge to support you and your equipment. CJD Equipment takes great pride in being Volvo CE's first and only authorised partner in Australia for over 25 years. Together, we provide a full range of machinery ideally suited to Australia's unique landscapes and industry requirements. These products are fully supported through a nationwide network of branches, and carefully selected dealers and service agents, strategically positioned to ensure total support.

With fully equipped and parts warehouses in every capital city, and dealers throughout major regional towns, we have the support network in place to ensure you're well supported, no matter where you or your machines are. Ongoing in-house training programs ensures our technicians' skills keep pace with the latest technology and product advances.

Head Office

54 Great Eastern Highway
South Guildford, WA 6055

Visit www.cjd.com.au

Call 1300 139 804

Email enquiries@cjd.com.au



[Facebook.com/cjdequipment](https://www.facebook.com/cjdequipment)



[Linkedin.com/company/cjd-equipment](https://www.linkedin.com/company/cjd-equipment)



[Instagram.com/cjd_equipment](https://www.instagram.com/cjd_equipment)

